



# Car DVR ND39w

FHD-1080P 2.0" TFT LCD



Instruction Manual

[www.nakamichicaraudio.com](http://www.nakamichicaraudio.com)



# Car Black Box

## 1. Product Structure

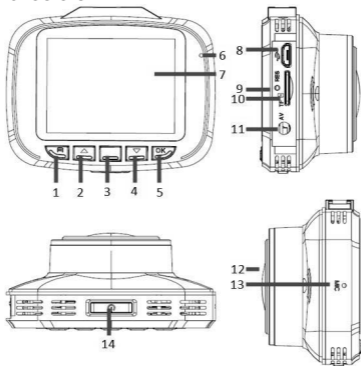

1. Menu; 2. Up; 3. emergency push button (Mode) ; 4. Down; 5. OK;
6. Indicating light; 7. Display screen; 8. USB Interface; 9. Reset; 10. TF slot;
11. AV input; 12. Camera; 13. MIC; 14. Power

## Preparation for First Use

### ● Installation

1. According to the interior environment, tightly fix the vehicle-mounted power cord; in order not to adversely affect your eyesight, the car black box shall be installed in front of the rear view mirror in the car. In this way, you can get a better and wider view.

2. Do not install the car black box at a

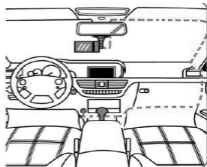

place where it will adversely affect the driver's attention or where it will block the driver's view.

3. For some cars, the power will be supplied to the car black box after the car is shut down; if so, it is mandatory to pull out the vehicle-mounted power, otherwise, accident will be resulted in.

4. Cable connection guideline:

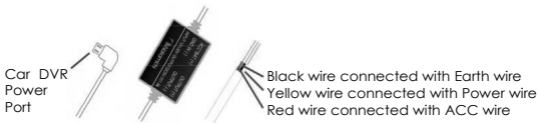

## ● On/Off

### 1. On:

- 1) The car black box will be started automatically when the car is started up;
- 2) The car black box can be started manually by pressing the On/Off button for one second, the blue indicating light is on, which means the car black box is started.

### 2. Off:



- 1) The car black box will be stopped automatically when the car is shut down;
- 2) The car black box can be stopped manually by pressing the On/Off button for one second.

## ● Selection of Memory Card

1. Memory card (micro SD card or micro SDHC card) shall be additionally bought by the user, which is not included in the car black box. Please use a 8GB -128GB card (legal copy), whose speed is at Class 10 or higher.
2. If you need to get out the memory card; then slightly press the bottom of the memory card, by which the card will be sprang up; get out the card with your fingers gently.
3. Before the first use, TF card shall be formatted.

## ● Software Setting:

**Note: after being powered on, the car black box is in the default of auto video; so the car black box can not be accessed to "Menu" (by pressing ) unless the video is stopped (press "OK").**

1. Language setting, press  "Menu", select "Hi" and press "OK", then the language can be set. Press "Up"  or press "Down"  to select the language that you want. Press "OK".

2. Time and Time Zone Setting

When using the car black box for the first time, on the home page, choose  and select "time setting" to well set the time and date.



3. As for other personalized settings,  can help you to fulfill all the settings that you want.



## 2. Mode Introduction and Use Instruction

**When video is not undergoing, press "Mode"  to do the switch-over as follows.**

### ● Video

Under the mode of "Video", the following functions can be available:

- Press up  can be accessed to, by which the recording  will be closed. If the recording is closed, the video is silent, which the user's privacy will be protected. Press  for a short term, the recording can be opened.

- Press "OK" to start the video. If the video is started, the  on the top left corner will be flashed; then press "OK" to stop the video and the  on the top left corner will be disappeared.

- When there is no need to video, press  to access to the setting of video.

- After the settings are finished, press  to back to the page where you were.

- Press  to lock the video undergoing; press  again, the video can be unlocked.





- Shortly press  to close the display screen; the screen can be waken up by pressing any button.

- Shortly press  to switch over the screen between the front camera and rear camera.





- Long press " " to start or close WIFI.

### ● **View**

Under the mode of View:

- Press " " or " " to select the "photo" or "video" that you want to check, then press "OK".
- Press " " to set the menu.
- After you made the choice, press "OK" to have a look and press " " to back to the page where you were.

Note:

1. If it is an SOS video, select it and press " ", by which the locked video can be unlocked.
2. If the video being checked is just an ordinary one, SOS video is required to be checked, press " " to access to the menu, where you will see "video type" (the last item), press "OK" to switch over to "emergency", then press " " to back to the page where you were. Then SOS video can be checked.
3. If the videos being checked are done previously while videos done lately are to be checked, press " " long for switch-over.

## **3. Use Instruction for Menu**

### ● **Menu Function for Video Mode**

**Video mode: High resolution 30fps (1280x720) and full high resolution 30fps (1920x1080)**

Note: If the resolution is different, the video will be presented at a sequence of from high resolution to low resolution.

**Video quality: Ultra high quality, high quality.**

Note: If the video quality is different, the video will be presented at a sequence of from high quality to low quality.

**Video time: 1min, 2min, 3min, 5min, 10min and close.**

Note: If the set time is closed, the video will be continuously made until the memory card is full; if the set time is X minutes, the videos will be stored every X min

**Shutdown video time: 0 minute, 5 seconds, 30 seconds, 1 minute and 3 minutes.**

Note: If the set time is 0 minute, the video will be automatically stored and the car black box will be powered off when the car is shut down; if the time is additionally set, the video will be delayed and stored automatically, and the car black box will be powered off when the car is shut down.

**Automatic video: Start and stop**

Note: when the car black box is powered on, automatic video will be started or stopped. If it is not opened, no video will be made.

**Sound Record: On and off**

Note: the sound can be recorded synchronously when the video is making; when the sound record is closed, the video will be silent.

**MIC: Standardized, low.**

Note: set sensitivity when the sound is being recorded synchronously when video is undergoing.

**LDWS : Start and stop.**

Note: it is an early warning system to remind the orbit displacement. That is when the car has orbit displacement, alarm will be given out to remind that the orbit is displaced if LDWS is started.

**FCWS: Start and stop.**

Note: it is an early warning system to remind the car in front. That is when the vehicle is too close to the car in front, alarm will be given out to remind the driver to keep a safety distance with the car in front.

● **System Setting**

**Sound on key-pressing: on / off;**

**Auto power-off: Never, 1 minute and 5 minutes;**

Note: when the camera is not under operation and it is not disturbed, the car black box will be powered off automatically after X minute(s).

**Time set: at 01:24:50 on Nov. 4, 2016.**

**Stamp: date/type/date +type/close.**

Note: at the left bottom, the date and time set for the video or photo will be displayed.

**Flash frequency: 50Hz and 60 Hz.**

**Automatic screen-off: close, 1 minute and 3 minutes.**

Note: if the camera is not operated for X minutes, camera will close LCD screen while LCD screen can be displayed by pressing any button.

**Protection sensitivity: Off, Class 0, Class 1, Class 2, Class 3 and Class 4.**

Note: Video is locked when there is vibration, the higher the Class is, the higher the sensitivity is.

**Shutdown supervision: Off, high, medium and low.**

Note: it is used when the car is shutdown. Once there is a serious vibration or shake, the camera will be started and recorded automatically; when the set time of video is due, the video will be stored and the camera will be closed.

**Motion detection: Off, low, medium and high.**

Note: after the camera is on, if there is no video undergoing and it detects that something in front is moving, the camera will start to make videos automatically.

**System reset: Confirm and cancel.**

Note: after resetting the system, the functions of camera will be backed to the default.

**Format SD card: Confirm and cancel.**

Note: confirm to format the SD card.

**LDWS calibration: To set.**



Adjust to adjust by pressing "▲" or "▼".

Exit cancel the adjust, back by pressing "☰".

Next :Press "OK" to the next. After the adjustment is fulfilled, press "OK" to store and exit.

Note: the line shown in the right photo is the distance between the car and the ground in vertical. For safety concern, it is suggested that the



distance for car shall be 120 while SUV shall be 150.

**Initial version: the version of software used by the camera.**

**Turn of videos made by rear camera: Start and stop.**

Note: the videos made by rear camera which has been installed can be turned, so that there will be no need to dismantle the camera if the installation is done oppositely.

**Mirroring of videos made by rear camera: Start and stop.**

Note: The videos made by rear camera which has been installed can be mirrored, satisfying clients' different demands.

## ● Use of WIFI

### ● Download and install the APP

**Android system:** Search "AITSmartCamV1" in "Myapp", download and install the APP.

It is recommended that VLC should be installed.

**iOS system: Search "AITSmartCamV1" in APP Store.**

### ● On/Off of WIFI

• Long press " " to open WIFI " " and connect with the intelligent device. Long press " " to close WIFI " ".

• Open the intelligent device and WIFI, search NPD\_CarDV\_WIFI (password: 1234567890"; if the connection is correctly done, the WIFI icon will be in green.

• Open the intelligent device " " AIT Smart cam V1, video-making, photo-taking and view can be available.

**Before use, please confirm the following items:**

1. Do not use it when there is strong magnetic field, static electricity and interference of wave (like near the micro-wave oven), otherwise, signals can not be received.

2. Do not connect with Wi-Fi when on the plane.

3. When connecting with Wi-Fi, please make sure the distance between the camera and the intelligent device is no more than 10m (32 inches) and there is no signal shielding.

4. The connection between the camera and the intelligent device shall be in the form of "one-to-one".

5. The system used by the intelligent device shall be iOS 6 or above or Android 4.0 or above.

● **Language**

English

Español

Русский

Traditional Chinese

Français

Japanese

#### **4. Product Feature**

- **Good looking**, the external shell can be in different colors.
- **With a high resolution camera in wide-angle lens (4-glass fish eye)**, which is portable and able to make videos at any place.
- **Sensitization parts dedicated for car black box** are used, which can get ultra clear photos at the place where it is dark.
- **WDR is used**, which is able to make the video efficiency more outstanding when there are hard lights, dazzles and halos. So that the efficiency in the night will be better.
- **Safer**: There is a built-in protection of battery protection, when the temperature is too high, the battery can be protected and liquid leakage from the battery can be prevented, fire and explosion can be avoided.
- **The video can be circulated**, that is the old videos can be deleted for new videos.
- **Video can be automatically started** when the car is started up.
- **There is a chip which is sensible to gravity**, by which the videos can be automatically protected (locking the videos) according to the car status.
- **When the car is shut down**, it is able to keep an eye on the car so that you can be better and comprehensively protected.

## 5. Technical Specification

LCD screen	2.0 high resolution
Camera angle	High resolution camera with a 4G wide
Lens aperture	F=2.0
Language	English / Spain / Russian / Traditional Chinese / French / Japanese (the default is "English")
Video	1080P 30fps/720P 60fps
Video format	MOV
Photo format	JPEG
Microphone/ speaker	Built-in
Light source	50Hz/60Hz
USB	USB2.0
Power	5.0V 1.5A
Battery	No

**Note: the right to modify the design and specification is reserved, which will not additionally notified. If there is a difference, please make the car black box you got as standard.**



Design and specifications are subject to change  
without notice

© 2017 Nakamichi  
[www.nakamichicaraudio.com](http://www.nakamichicaraudio.com)

